

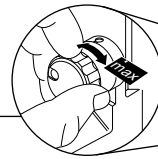

P-System

www.lamello.com



P-System Fräser Art.Nr.
 Ø 100.4 x 7 x 22 mm, Z3
 Diamant für Zeta P2 **132140**
 Hartmetall für Zeta P2 **132141**

Clamex P-14

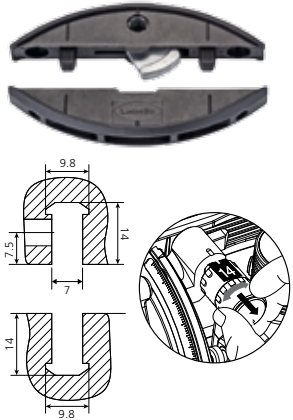

Wiederlösbarer Möbelverbinder

Grösse 66 x 27 x 9.7 mm

Zugbruchfestigkeit

Spanplatte besch.: ~ 800 N
Buche massiv: ~ 1'000 N

Art.Nr.

80 Paar	145334
300 Paar	145346
1000 Paar	145356

Clamex P-10

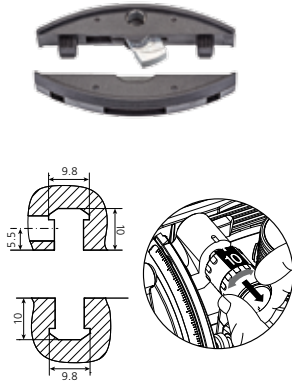

Wiederlösbarer Möbelverbinder

Grösse 52 x 19 x 9.7 mm

Zugbruchfestigkeit

Spanplatte besch.: ~ 600 N
Buche massiv: ~ 900 N

Art.Nr.

80 Paar	145372
300 Paar	145373
1000 Paar	145374

Clamex P Medius 14 / 10

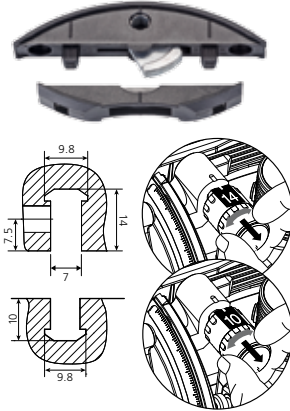

Wiederlösbarer Möbelverbinder für Mittelwände

Grösse 66 x 13.5 x 9.7 mm
52 x 7.5 x 9.7 mm

Zugbruchfestigkeit

Spanplatte besch.: ~ 700 N
Buche massiv: ~ 900 N

Art.Nr.

80 Paar	145370
300 Paar	145371
1000 Paar	145357

Bisco P-14

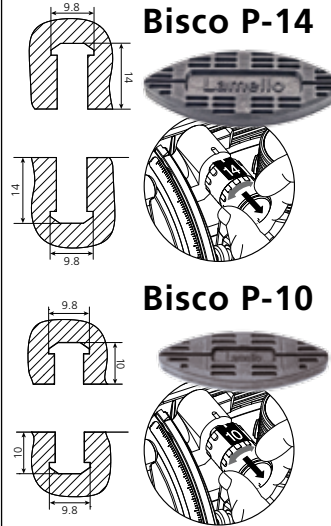

Richtlamelle passend zu Clamex P-14 + Tenso P-14 bzw. Clamex P-10

Grösse
Bisco P-14 65 x 27 x 7 mm
Bisco P-10 52 x 19 x 7 mm

Art.Nr.

80 Paar	145301
300 Paar	145302
1000 Paar	145303
Bisco P-10 Art.Nr.	
80 Paar	145304
300 Paar	145305

Bisco P-14 ist bestens geeignet für Trockenverbindungen vor dem Verleimen mit Tenso P-14

Tenso P-14

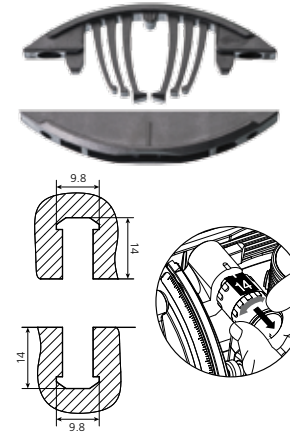

Selbstspannender Verbinder zum Verleimen

Grösse 66 x 27 x 9.7 mm

Anzugskraft

pro Verbinder: ~ 150 N

Art.Nr.

80 Paar	145415
300 Paar	145425
1000 Paar	145435

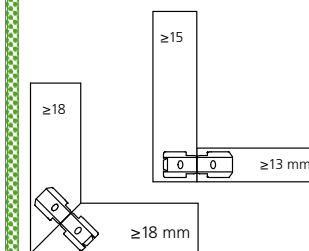

Divario P-18

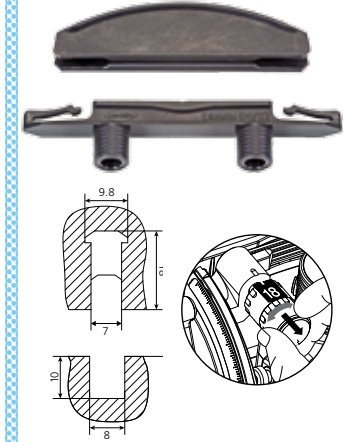

Selbstspannender unsichtbarer Verbinder für Tablarböden

Grösse 65 x 16 x 9.7 mm
Ø 8 x 9 mm

Zugbruchfestigkeit

für alle Materialien: ~ 600 N

Art.Nr.

80 Paar	145550
300 Paar	145560
1000 Paar	145570

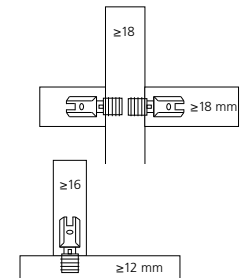
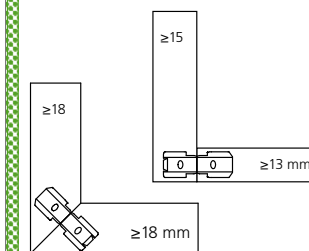
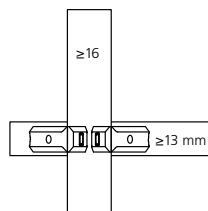
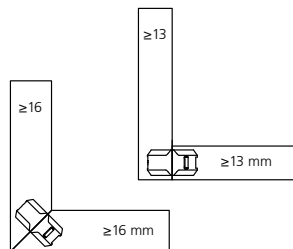
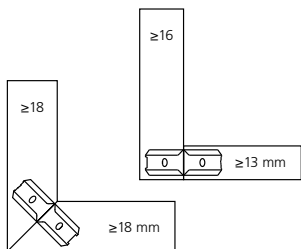
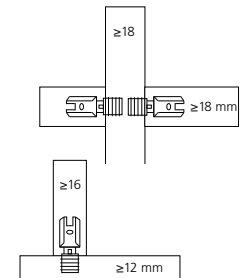



Lamello-System

www.lamello.com



HW-Nutfräser	Art.Nr.
Ø 100 x 4 x 22 mm	
für Zeta, Top, Classic	132000
für Classic	132106

Original Holzlamellen

0	Art.Nr.
1000 Stück	144000
Grösse	47 x 15 x 4 mm

10	Art.Nr.
1000 Stück	144010
Grösse	53 x 19 x 4 mm

20	Art.Nr.
1000 Stück	144020
Grösse	56 x 23 x 4 mm

E 20-L

Selbstspannende Einschlaglamelle	
Grösse	56 x 11.5 x 4 mm
Art.Nr.	
80 Stück	145022
400 Stück	145025
1200 Stück	145027

Clamex S-18*

Verbinder zum Einschrauben	
Grösse	66 x 29 x 8 mm
Art.Nr.	
18 Paar	145231
80 Paar	145236
300 Paar	145241

* Wendeschneidenfräser
Ø 100 x 8 x 22 mm, Art.Nr. 132108

Fast

Steckverbinder	
Grösse	56 x 25.4 x 4 mm
Art.Nr.	
50 Paar	145120

Metal

Schiebeverbinder	
Grösse	57.2 x 25.4 x 4 mm
Art.Nr.	
40 Paar	145115

Champ

Schiebeverbinder	
Grösse	64 x 24 x 4 mm
Art.Nr.	
50 Paar	145110

H9**

Art.Nr.	
1000 Stück	144009
Grösse	38 x 12 x 3 mm

**HW-Nutfräser
Ø 78 x 3 x 22 mm, Art.Nr. 132009

S6	Art.Nr.
1000 Stück	144006
Grösse	85 x 30 x 4 mm

E 20-H

Selbstspannende Einschlaglamelle	
Grösse	23 x 28 x 4 mm
Art.Nr.	
80 Stück	145021
400 Stück	145026
1200 Stück	145028

K 20

Haftlamelle	
Grösse	60 x 24 x 4.5 mm
Art.Nr.	
80 Stück	145001
250 Stück	145000

C 20 / C 10

Lamelle für Corian	
C 20, Grösse	60 x 23 x 4 mm
C 10, Grösse	53 x 19 x 4 mm
Art.Nr.	
C 20, 250 Stück	145010
C 10, 300 Stück	145012

Simplex

Schiebeverbinder	
Grösse	54 x 23 x 4.1 mm
Art.Nr.	
50 Paar	166101
100 Paar	166100

Duplex

Schiebeverbinder	
Grösse	66 x 29 x 4 mm
Art.Nr.	
Vernickelt	
20 Stück (links)	166011
20 Stück (rechts)	166012
je 10 Stück	166013